

Model Number: CWEH6-K42

Special Notes: LED GU10 lighting. This model is not available with heat lamps. Shown with optional duct cover (sold separately). Optional duct covers are available in standard and custom sizes.

WIDTH:	42"
DEPTH:	19 1/2"
HEIGHT:	6"
CFM:	250
SONES:	7.4
AMPS:	3.5
# LIGHTS:	3

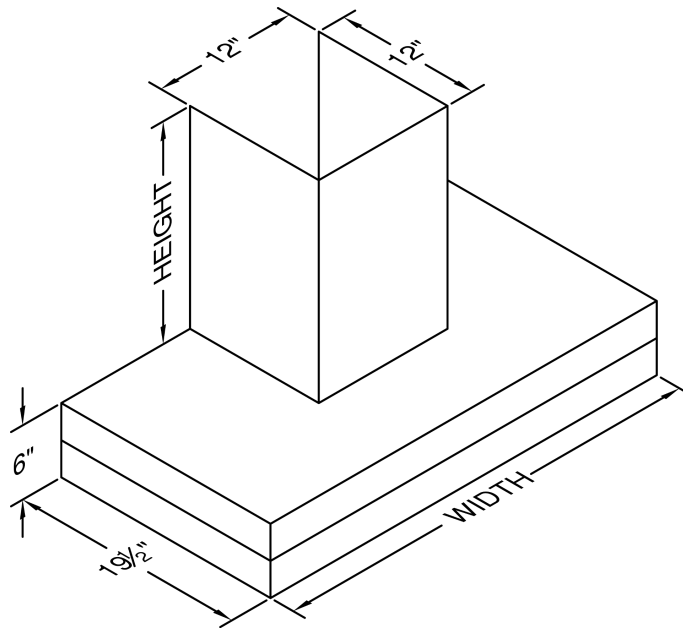

The VP521 transition is available for top vent applications at an additional charge.

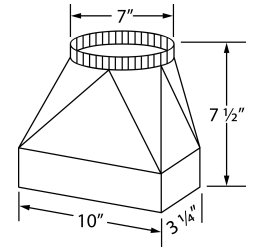

CONNECTION DIAGRAM

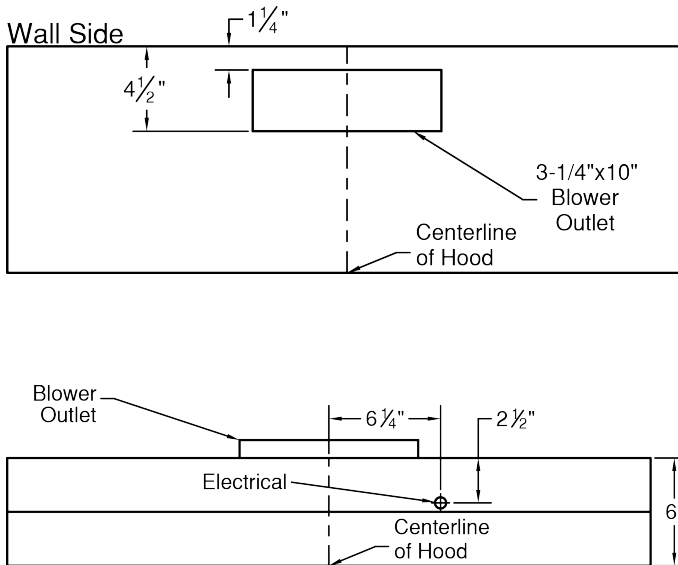

REC. MOUNTING HEIGHT*

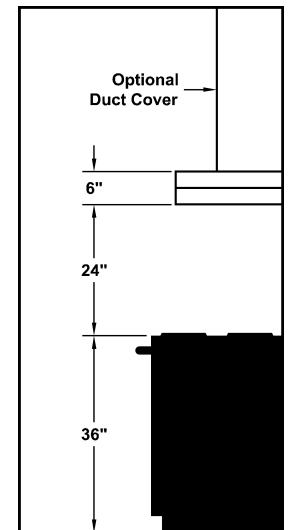

* Exceeding recommended mounting height may compromise performance.

ELECTRICAL/MECHANICAL SPECIFICATIONS FOR BLOWER UNIT

MODEL	VOLTS	AMPS+	HZ	RPM	CFM SP@0.0"	EQUIV CFM\$	CFM SP@0.1"	CFM SP@0.2"	CFM SP@0.3"	MIN. ROUND DUCT SIZE	SONES#
K250 (Top Vent)	115	3.5	60	1550	250	375	223	220	190	7" (38 sq. in.)	7.4

+ This model is equipped with LED GU10 lighting: (2 lights: 30" - 41", 3 lights: 42" - 48").

\$ Because the Power Lung#8482; blower uses centrifugal filtration rather than conventional baffle or mesh filters, the Power Lung#8482; blower can handle cooking equipment with higher cubic feet per minute (CFM) requirements and can deliver equivalent CFM much more efficiently than other filtration systems. When comparing the Power Lung#8482; with other blower units made by other manufacturers, use the "Equivalent CFM".

Ratings in accordance with the Standard Test Code by the Energy Systems Laboratory of the Texas Engineering Experiment Station.