

SFU4300MX

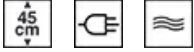

Category	Compact 24"
Product family	Oven
Power supply	Electrical
Cooking method	Microwave with grill
EAN code	8017709310295



Aesthetic

Aesthetics	Classic	Silkscreen color	Black
Color	Stainless steel	Silkscreen type	Symbols
Finishing	Fingerprint-proof	Handle	Classic
Design	Flat	Handle color	Stainless steel
Material	Stainless steel	Logo	Embossed
Stainless steel type	Brushed		

Controls

			
Display name	DigiScreen	Controls setting	Control knobs
Display technology	LED	No. of controls	2

Programs / Functions

No. of cooking functions	3
Traditional cooking functions	



Microwave functions



Options

Time-setting options	End-of-cooking automatic shut-off	Timer	1
Minute minder	Yes		

Technical Features



No. of shelves	2	Grill element - power	1200 W
Shelves type	Metal racks	Total no. of door glasses	3
No. of lights	1	Microwave stops when door is opened	Yes
Light power	20 W	Cooling duct	Single
Light on when door is open	Yes	Cavity material	Stainless steel
Turntable	Yes	Microwave screen protection	Yes
Turntable dimension	12 1/2 "		

Performance / Energy Label

Volume of the cavity	1.34 cu. ft.	Microwave effective power	1000 W
Number of cavities	1		

Accessories Included

Rack	2
-------------	---

Electrical Connection

Voltage	240 V	Voltage	120/208 V
Current	14.2 A	Frequency	60 Hz
Nominal power	3400 W	Power cord length	59 1/16 "

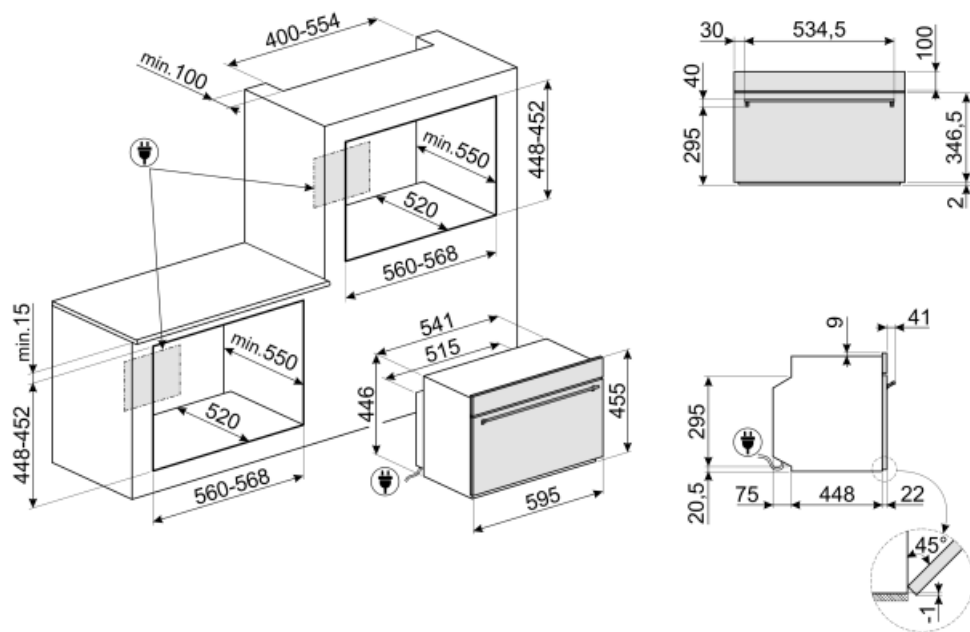









Not included accessories



KIT4300MX

Symbols glossary (TT)

	Microwave energy shortens cooking times dramatically and produces energy savings.		Triple glazed doors: Number of glazed doors.
	Electric		Grill element: Using of grill gives excellent results when cooking meat of medium and small portions, especially when combined with a rotisserie (where possible). Also ideal for cooking sausages and bacon.
	Microwave: Penetrating straight into the food, microwaves cook very quickly and with considerable energy savings. Suitable for cooking without fat, they are also able to thaw and heat food without altering its original appearance and aroma. The microwave function can also be combined with conventional functions with all the resulting advantages. Ideal for all types of food.		Microwave + grill element: The use of the grill results in a perfect browning of the surface of the food. The action of microwaves allows instead of cooking in a short time the internal part of the food.
	Compact appliances with a height of 45 cm - perfect solution to meet the functional requirements of kitchen sets of small height. Available in several types and in different styles.		The oven cavity has 2 different cooking levels.
	...		