

Specifications:

Installation:	Vanity-top
Exterior Dimensions:	72" w x 22" d x 6 1/4" h
Material:	Solid surface
Weight:	Matte white - 64 lbs Gloss white - 80 lbs
Overflow:	Yes
Finishes:	001M - Matte white 001G - Gloss white
Faucet Holes:	00 - no hole 01 - one centered hole 02 - two hole - center and right, 4" spread 03 - three hole, 8" spread
Faucet Hole Size:	Ø 1 3/8"
Drain Hole Size:	Ø 1 3/4"
Cutout Size:	70" x 20" (template available upon request)

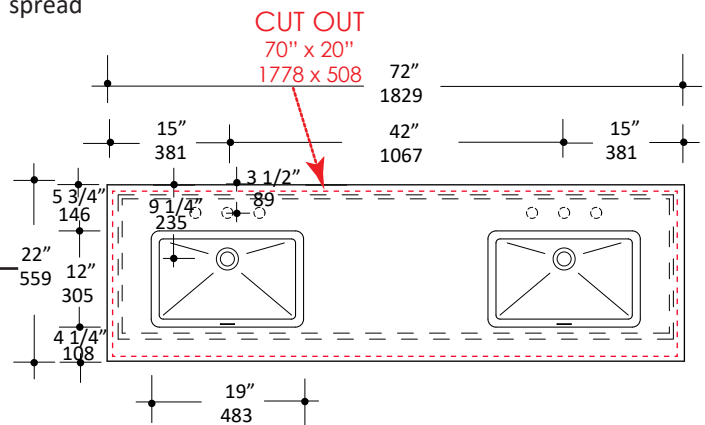

Features:

- European size drain
- Heat, stain, scratch, chemical, impact resistant
- Optional backsplash available

Codes + Standards:

- Meets and exceeds applicable national codes and standards



compliant when installed to specific requirements of this regulation

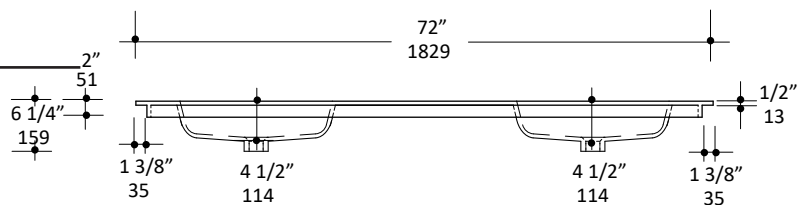

Recommended Items:

- Furniture
 - KUB-W-72 - Floor-standing or wall mounted vanity with drawers
 - BKS - 6" Backsplash 001G - gloss, 001M - matte
- European drain with overflow
 - 7100-12
 - 7100-16OF
 - 7100-13OF

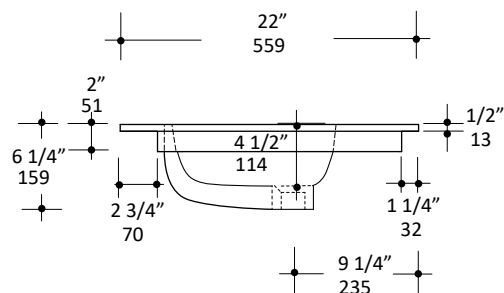

LACAVA reserves the right to revise any dimension or information on this sheet without notice. Dimensions are nominal and may vary within an industry accepted tolerance of 1/4".
Drawings provided herein are meant to give the user an idea of the product and are not made to scale.
Revised: 8/12/2019