

Features

- Single lever handle allows for both volume and temperature control
- 5-1/2" (140 mm) spout reach.
- 1.2 gal/min (4.5 l/min) maximum flow rate [max at 60 psi (4.14 bar)].
- Includes metal pop-up drain with 1-1/4" tailpiece.
- KOHLER ceramic disc valves exceed industry longevity standards for a lifetime of durable performance.
- Temperature memory allows faucet to be turned on and off at the temperature set during prior usage.
- Coordinates with Purist faucets, accessories, and showering components to complete your bathroom.
- Low-flow aerator available (please see latest price book).

Material

- Premium Metal Construction.
- KOHLER finishes resist corrosion and tarnishing.

Installation

- For single-hole installation.
- Pre-attached flexible supply lines simplify installation.



ADA **CSA B651** **OBC**

Codes/Standards







ASME A112.18.1/CSA B125.1
 NSF/ANSI 61
 NSF/ANSI 372
 All applicable US Federal and State material regulations
 DOE - Energy Policy Act 1992
 EPA WaterSense®
 California Energy Commission (CEC)
 ADA
 ICC/ANSI A117.1
 CSA B651
 OBC

KOHLER® Faucet Lifetime Limited Warranty

See website for detailed warranty information.

Available Colors/Finishes

Color tiles intended for reference only.

Color	Code	Description
	CP	Polished Chrome
	SN	Vibrant® Polished Nickel
	BGD	Vibrant® Moderne Brushed Gold
	BN	Vibrant® Brushed Nickel
	BV	Vibrant® Brushed Bronze
	BL	Matte Black

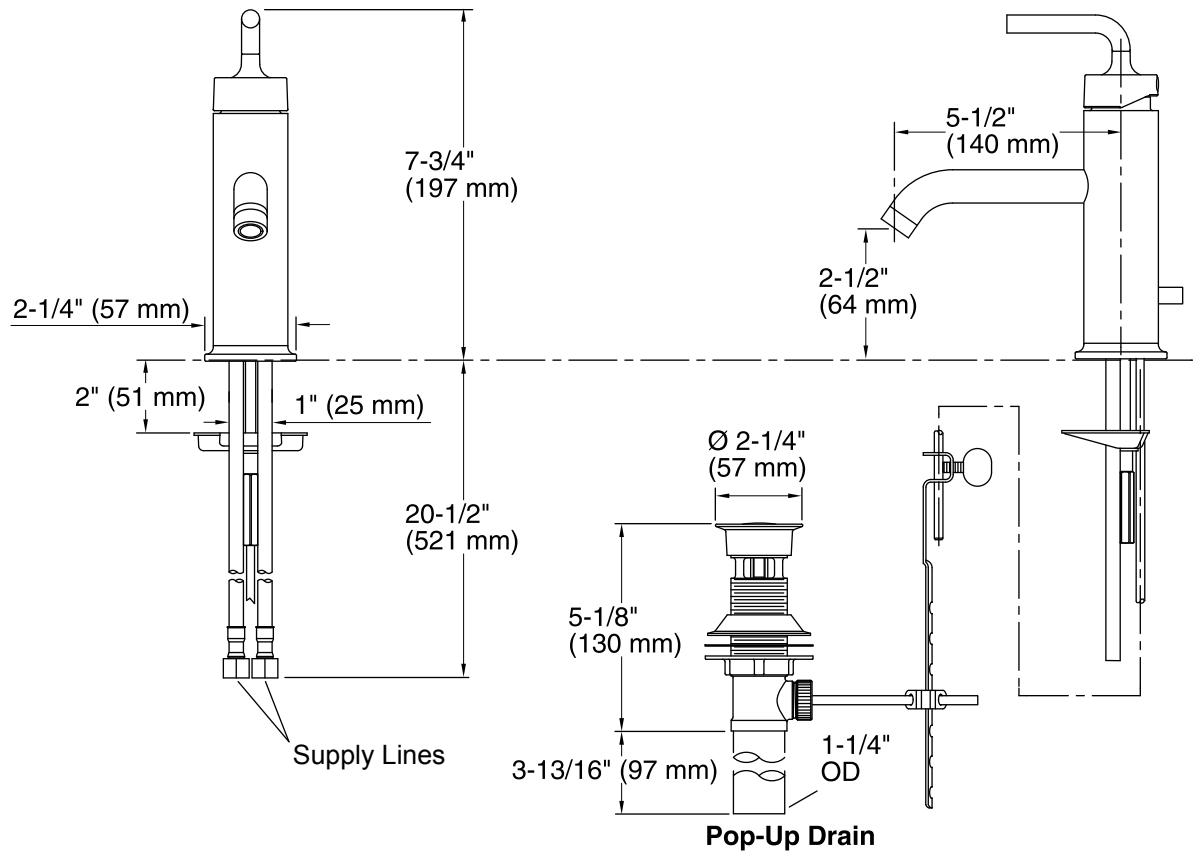

Technical Information

All product dimensions are nominal.

Faucet:

Flow rate: 1.2 gal/min (4.5 l/min)

Pressure: 60 psi (4.1 bar)

Drain included: Yes

Drain tailpiece included: Yes

Spout:

Spout reach: 5-1/2" (140 mm)

Notes

Install this product according to the installation guide.

ADA, OBC, CSA B651 compliant when installed to the specific requirements of these regulations.