

### Features

- 33-inch minimum base cabinet width.
- Large single bowl.
- 9-inch depth.
- Three faucet holes with one accessory hole to the right.

### Material

- KOHLER® enameled cast iron.

### Installation

- Top-mount

### Recommended Products/Accessories

- K-9000 P-Trap
- K-6063 Sink Rack
- K-6377 Sponge Caddy
- K-6378 Kitchen Brush Caddy
- K-6379 Kitchen Squeegee
- K-6382 Disinfecting Wipes Dispenser
- K-6383 Soap Dispenser
- K-8618 Paper Towel Holder
- K-8619 Flexible Kitchen Mat
- K-8624 Dish Scraper
- K-8801 Sink Strainer
- K-8799 Sink Strainer

### Optional Products/Accessories

- K-6637 Cutting Board



### Codes/Standards









ASME A112.19.1/CSA B45.2

### KOHLER® Enameled Cast Iron Kitchen Sink Lifetime Limited Warranty

See website for detailed warranty information.

### Available Colors/Finishes

*Color tiles intended for reference only.*

Color	Code	Description
	0	White
	FF	Sea Salt™
	96	Biscuit
	47	Almond
	FD	Cane Sugar™
	95	Ice™ Grey
	K4	Cashmere
	7	Black Black™

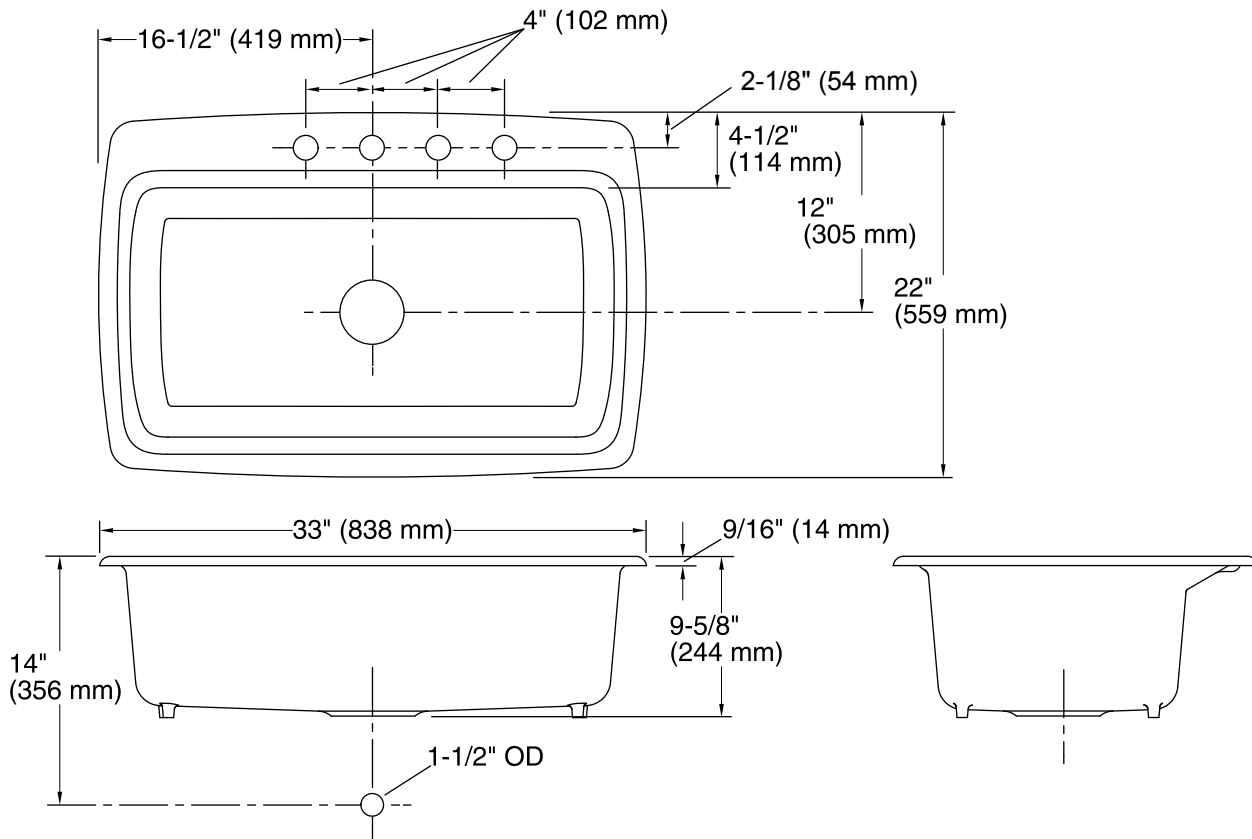

## Technical Information

All product dimensions are nominal.

Bowl configuration:	Single
Installation:	Top-mount
Cutout:	Top-mount, 30-1/2" x 20-1/8" (775 mm x 511 mm) with 1-1/2" (38 mm) radius corners
Min. base cabinet width:	33" (838 mm)
Bowl area:	Length: 29" (737 mm) Width: 15" (381 mm) Bowl depth: 9" (229 mm)
Number of deck holes:	4
Faucet hole spacing:	4" (102 mm)
Faucet hole(s):	1-3/8" (35 mm)
Drain hole:	3-5/8" (92 mm)

## Notes

Install this product according to the installation instructions.