



Glen Falls™

Top-/Under-Mount Utility Sink

K-19017-2

Features

- Fits minimum 27-inch base cabinet if installed as top-mount or under-mount.
- Single bowl.
- 13-inch depth provides generous workspace.
- Two faucet holes.

Material

- KOHLER® enameled cast iron.

Installation

- Dual-mount sink can be installed as top-mount or under-mount.
- Under-mount installation kit not included.

Recommended Products/Accessories

- K-9000 P-Trap
- K-8801 Sink Strainer
- K-8799 Sink Strainer



Codes/Standards







ASME A112.19.1/CSA B45.2

KOHLER® Enameled Cast Iron Kitchen Sink Lifetime Limited Warranty

See website for detailed warranty information.

Available Colors/Finishes

Color tiles intended for reference only.

| Color | Code | Description |
|--|------|--------------|
|  | 0 | White |
|  | FF | Sea Salt™ |
|  | 96 | Biscuit |
|  | 47 | Almond |
|  | 95 | Ice™ Grey |
|  | FT | Basalt |
|  | 7 | Black Black™ |

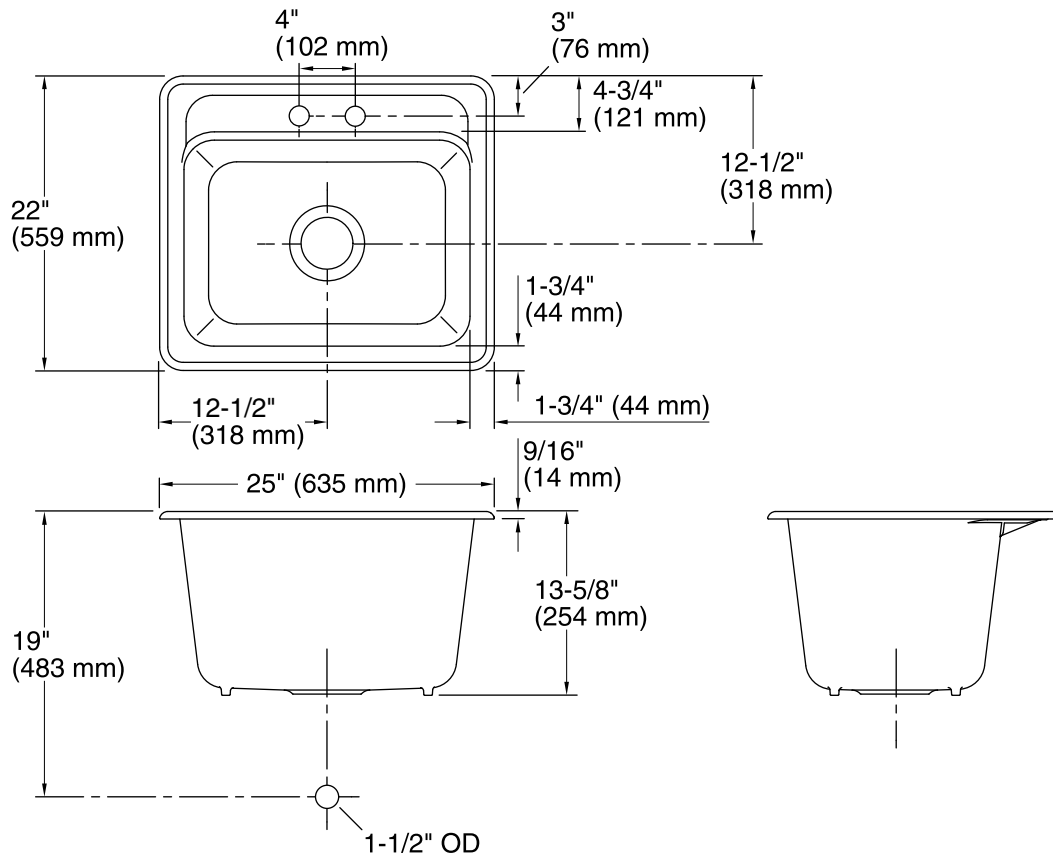

Technical Information

All product dimensions are nominal.

| | |
|--------------------------|--|
| Bowl configuration: | Single |
| Installation: | Top-mount, Under-mount |
| Min. base cabinet width: | 27" (686 mm) |
| Bowl area (Only): | Length: 21-1/2" (546 mm) Width: 15-1/2" (394 mm) Bowl depth: 13" (330 mm) Water depth: 13" (330 mm) |
| Number of deck holes: | 2 |
| Faucet hole(s): | 1-3/8" (35 mm) |
| Drain hole: | 3-7/8" (98 mm) |
| Template: | 1079983-7, required, included |

Notes

Install this product according to the installation instructions.