

30" DUAL FUEL RANGE



A synthesis of beauty and functionality, the Majestic II series provides a premier cooking experience. As the centerpiece of your kitchen, it boasts handcrafted details such as rounded lines, custom finishes, ergonomic design, and innovative technology, inspired by the professional cooking world.

Fuel Type..... **Dual Fuel**
 Gas Type..... **Liquid Propane or Natural Gas**

OVEN COLORS



TRIM*

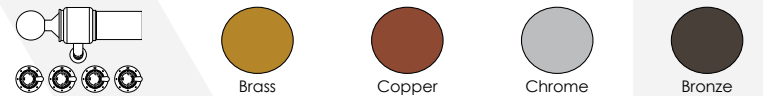

*Trim colors are available for every range color.

FEATURES

Cooktop

Cooktop surface.....	Deep Recessed
Number of Burners/Elements.....	5
Gas Heat Configuration.....	Sealed Burners
Burner/ Element Fuel.....	Gas
Grate Type.....	Cast Iron
Cooktop Control Type.....	Knobs
Cooktop Control Location.....	Front
Burner Output No. 1.....	10,500 BTU/ Large Burner
Burner Output No. 2.....	15,500 BTU/ Dual Burner
Burner Output No. 3.....	6,100 BTU/ Small Burner
Burner Output No. 4.....	6,100 BTU/ Small Burner
Burner Output No. 5.....	10,500 BTU/ Large Burner

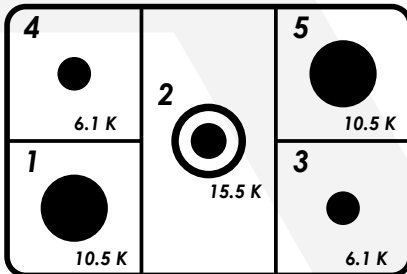

Oven

Oven Fuel.....	Electric
Oven Door Type.....	Triple-Layer Glass Door
Oven Type.....	Convection
Oven Cleaning Type.....	Self-Clean Mode
Oven Control Type.....	Display
Oven Control Place.....	Front
Oven Light(s).....	2
Oven Light Type.....	LED
No. of Rack Holders.....	5
Rack Placement Type.....	Plain
Soft Close Door.....	Yes
Display.....	TFT Touchscreen
Broiler.....	Electric
Child Safety Lock.....	Yes
Timer.....	Yes
Built-in Thermostat.....	Yes
Internal Thermometer.....	Yes

INCLUDED

Range Hood.....	No	Oven Racks.....	2
Power Cord.....	Yes	Oven Trays.....	2
Grate.....	Yes	Rotisserie.....	1
Griddle.....	No	Gas Regulator.....	1
Backsplash.....	1	Manual.....	Yes
Conversion Kit.....	Yes		

POWER

Voltage.....	220 v
Amperage.....	30 amps
Hertz.....	60 (Hz)
Power Cord Length.....	45 11/16" / 116 cm
Power Cord Type.....	Hard wire

RECOMMENDED ACCESSORIES

Wok Ring.....	A09234
Steam Cooker Basins.....	G00202

MISCELLANEOUS

Warranty Length.....	2 years
Warranty Type.....	Limited
Actual Weight.....	350 lbs / 158 kg
Product Material.....	Stainless Steel

DIMENSIONS

RANGE

Range Width.....	29 15/16" / 76 cm
Range Height without legs.....	33 7/16" / 85 cm
Range Min. Height with legs.....	34 1/16" / 86.5 cm
Range Max Height with legs.....	34 1/16" / 86.5 cm
Range Depth.....	26 9/16" / 67.5 cm
Backsplash Width.....	29 15/16" / 76 cm
Backsplash Height.....	2 6/16" / 6 cm
Backsplash Depth.....	9/16" / 1.5 cm
Oven Handle Length.....	21 1/16" / 53.5 cm
Oven Handle Depth over Range.....	2 3/16" / 5.5 cm
Power from bottom.....	14 9/16" / 37 cm
Power from right side.....	5 2/16" / 13 cm
Gas connector from bottom.....	5 2/16" / 13 cm
Gas connector from right side.....	3 15/16" / 10 cm

COOKTOP

Cooktop Width.....	29 15/16" / 76 cm
Cooktop Depth.....	27 9/16" / 70 cm
Cooktop Height.....	1 9/16" / 4 cm
Cooktop Front Lip Depth over Range.....	2/16" / 0.3 cm
Cooktop Back Lip Depth over Range.....	1 3/16" / 3 cm

OVEN

Oven Capacity.....	4 cu. ft.
Oven Depth with Door Open 90°.....	19 5/16" / 49 cm
Oven Interior Width (Actual).....	25" / 63.5 cm
Oven Interior Height (Actual).....	16 15/16" / 43 cm
Oven Interior Depth (Actual).....	16 5/16" / 41.5 cm
Oven Interior Width (Usable).....	23 4/16" / 59 cm
Oven Interior Height (Usable).....	16 15/16" / 43 cm
Oven Interior Depth (Usable).....	16 5/16" / 41.5 cm
Height between Rack Plates.....	1 9/16" / 4 cm
Height between lowest and highest rack.....	9 7/16" / 24 cm

LEGS

Range Leg Type.....	Leveling
Range Leg Number.....	4
Adjustable Range Legs.....	No
Levelable Range Legs.....	Yes
Range Leg Min. Height.....	9/16" / 1.5 cm
Range Leg Max. Height.....	9/16" / 1.5 cm
Space Between Leg and Range (Side).....	0" / 0 cm
Space Between Leg and Range (Front).....	1 15/16" / 5 cm
Space Between Leg and Range (Back).....	0" / 0 cm

OVERALL DIMENSIONS

Width.....	29 15/16" / 76 cm
Maximum Height.....	35 10/16" / 90.5 cm
Minimum Height.....	35 19/16" / 90.5 cm
Depth (with handle).....	29 12/16" / 75.5 cm
Depth (without handle).....	27 9/16" / 70 cm

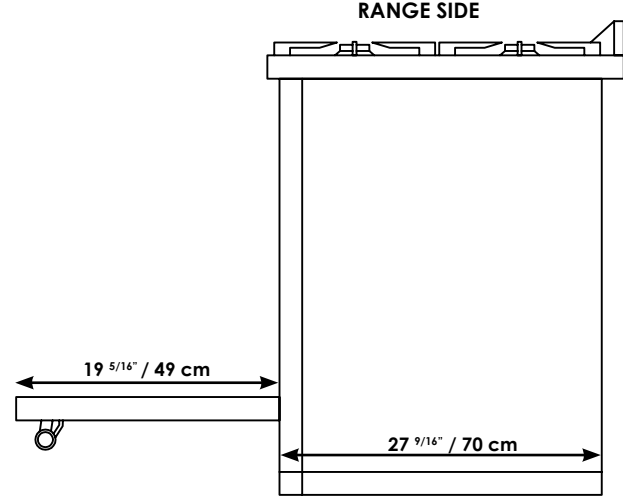
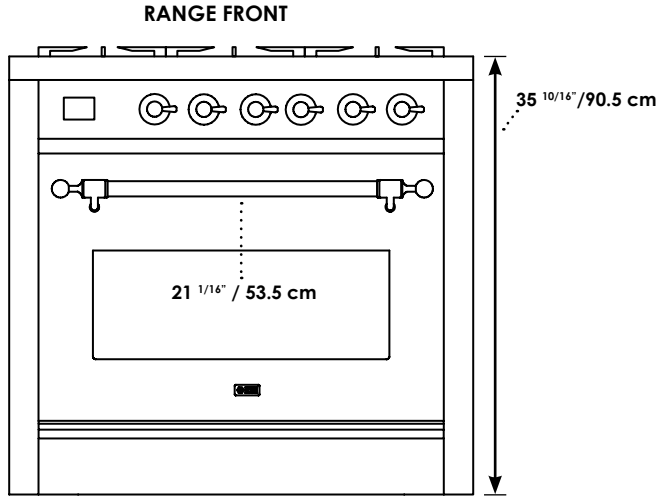

Main Oven Capacity: 4 cu. ft.*

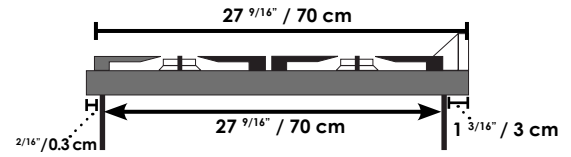
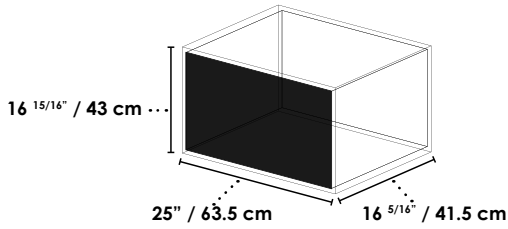

*Oven Capacity's cubic feet is manufacturer's measurement prior to installation of broiler, oven racks, and convection fan. Usable space differs from Actual space due to the rack placements and rotisserie.

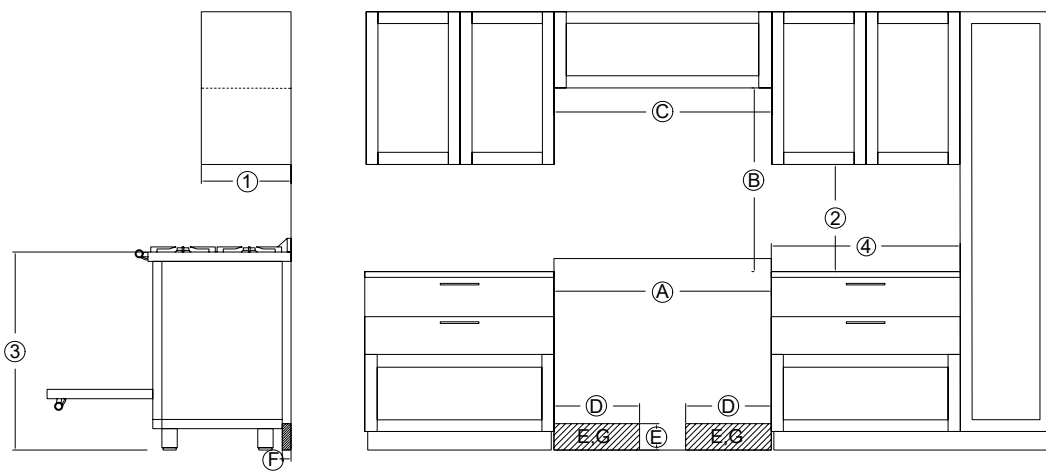

The Shaded Area represents the installation area for the connections:
E ; Electric Connection
G ; Gas Connection

DIMENSIONS	DESCRIPTION
1 13" (330 mm)	Maximum depth of top cabinet
2 18" (547 mm)	Minimum distance to bottom edge of top cabinet
3 35 1/2"-37" (901-940 mm)	Distance from the floor to cooktop surface
4 12"	Minimum distance from cooktop surface
A 29 15/16" (76 cm)	Width of cabinet opening
B 28" (71.12 cm) to 32" (81.28 cm)	Minimum distance between the top of the cooking area and bottom of an unprotected combustible surface
C 29 15/16" (76 cm)	Width of the hood area
D Approx. 10 3/16" (274mm)	Maximum connection with right and left
E Approx. 4 1/2" (115mm)	Maximum connection height
F Approx. 2 3/16" (72mm)	Maximum connection depth