

 **FABER**

**BACKSPASH KIT
KIT DOSSERET
KIT DE PROTECTOR CONTRA SALPICADURAS**

Installation Instructions

Instructions d'installation



Instrucciones de instalación

BACK30
BACK36
BACK48

PARTS/ PIÈCES/ PIEZAS

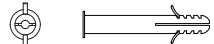

PARTS INCLUDED

REF.	PART	QTY
	Backsplash	2

REF.	PART	QTY
	Pozi Screws (Screws 3/16" x 1-15/16") 	9
	Wall plug (3/16" x 2-3/4") 	9



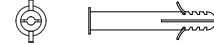

PIÈCES INCLUSES

RÉF.	PIÈCE	QTÉ
	Dossieret	2

RÉF.	PIÈCE	QTÉ
	Vis Pozi (Vis 3/16" x 1-15/16") 	9
	Prise murale (3/16" x 2-3/4") 	9

PIEZAS INCLUIDAS

REF.	PIEZA	CANT
	Protector contra salpicaduras	2

REF.	PIEZA	CANT
	Tornillos Pozi (Tornillos 3/16" x 1-15/16") 	9
	Enchufe de pared (3/16" x 2-3/4") 	9

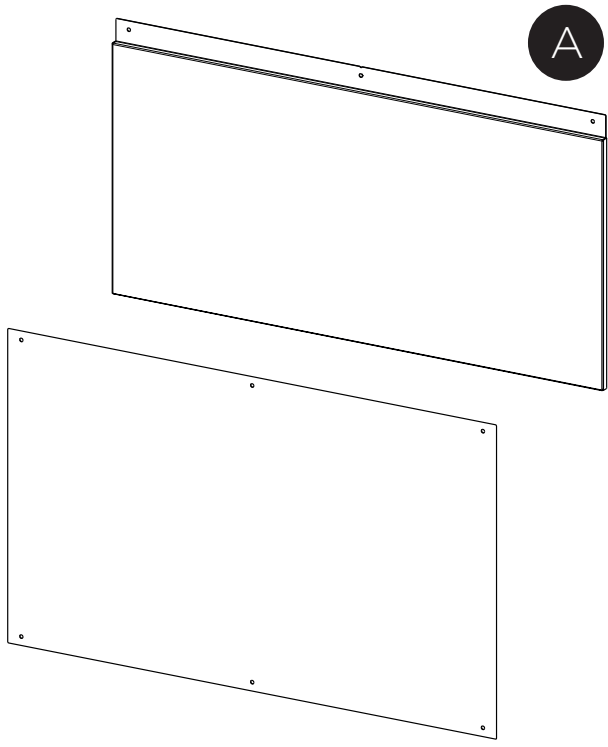

30"

36"

48"

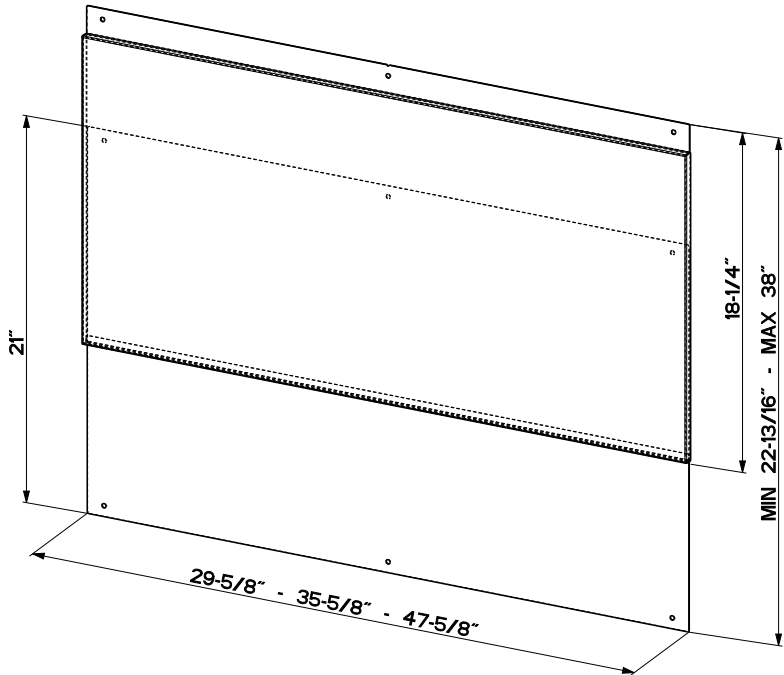
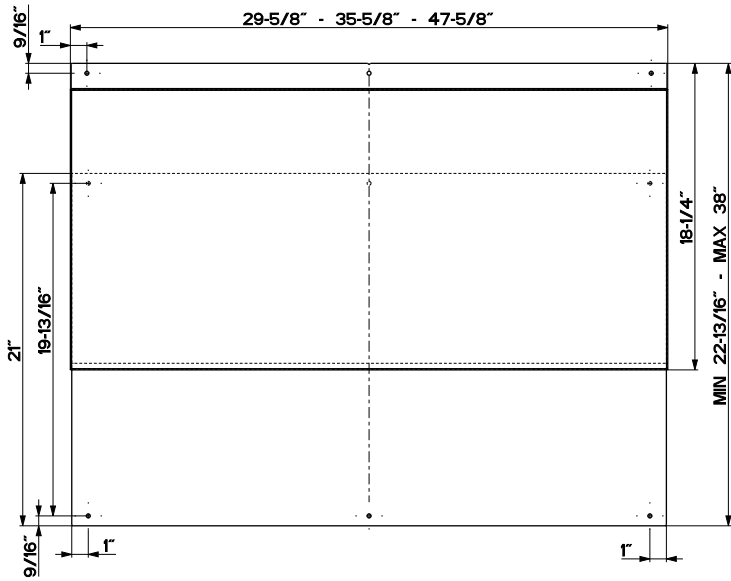

INSTALLATION

WARNING! The backsplash should be installed before the hood is installed.

1. Position the lower section of backsplash on the wall. Center it side to side and mark the mounting holes. Remove the lower section from the wall.
2. Attach the lower section of the backsplash to the wall with the 6 screws (G) provided.
3. Position the upper section of the backsplash on the wall. The top position of the upper section should be at least 1" above the bottom of the hood so the recessed screws are covered. Center it side to side and mark the holes. Remove the upper section from the wall.
4. Peel off the double-sided tape. Attach the upper section to the wall with 3 screws (G) provided.
5. Press the upper section to the lower section to make sure the tape fully adheres to the lower section.

CLEANING STAINLESS STEEL

Cleaning Exterior surfaces:

Please note, abrasives and scouring agents can scratch range hood finishes and should not be used to clean finished surfaces.

Stainless Steel finish cleaning instructions:

Clean exterior surfaces with a commercially available stainless steel cleaner.

INSTALLATION

AVERTISSEMENT ! Le dossieret doit être installé avant la pose de la hotte.

1. Positionnez la partie inférieure du dossieret sur le mur. Centrez-la d'un côté à l'autre et marquez les trous. Retirez la partie inférieure du mur.
2. Fixez la partie inférieure du dossieret au mur à l'aide des vis fournies.
3. Placez la partie supérieure du dossieret sur le mur. La partie supérieure doit être placée à au moins 1" au-dessus du bas de la hotte pour que les vis encastrées soient couvertes. Centrez-la d'un côté à l'autre et marquez les trous. Retirez la partie supérieure du mur et installez-la avec les vis (**G**) dans les trous marqués.
4. Décollez le ruban adhésif double face. Fixez la partie supérieure au mur avec les vis fournies.
5. Utilisez le ruban adhésif double face pour coller les parties supérieure et inférieure ensemble.

NETTOYAGE DE L'ACIER INOXYDABLE

Nettoyage des surfaces extérieures :

Veillez noter que les abrasifs et les agents de récurage peuvent rayer les finitions de la hotte et ne doivent pas être utilisés pour nettoyer les surfaces de finition.

Instructions de nettoyage de la finition en acier inoxydable :

Nettoyez les surfaces extérieures avec un nettoyant pour acier inoxydable disponible dans le commerce.

INSTALACIÓN

¡ADVERTENCIA! El protector contra salpicaduras debe instalarse antes de la instalación de la campana.

1. Coloque la sección inferior del protector de salpicaduras en la pared. Céntrela de lado a lado y marque los orificios. Retire la sección inferior de la pared.
2. Fije la sección inferior del protector de salpicaduras a la pared con los tornillos suministrados.
3. Coloque la sección superior del protector de salpicaduras en la pared. La posición de la sección superior debe estar al menos 1" por encima de la parte inferior de la campana para que los tornillos empotrados queden cubiertos. Céntrela de lado a lado y marque los orificios. Retire la sección superior de la pared e instálela con tornillos (**G**) en los agujeros marcados.
4. Retire la cinta adhesiva doble faz. Fije la sección superior a la pared con los tornillos suministrados.
5. Utilice la cinta adhesiva doble faz para adherir las secciones superiores con las inferiores.

LIMPIEZA DEL ACERO INOXIDABLE

Limpieza de las Superficies Exteriores:

Por favor, tenga en cuenta que los abrasivos y los agentes de fregado pueden rayar los acabados de la campana extractora y no deben utilizarse para limpiar las superficies acabadas.

Instrucciones para la limpieza del acabado de Acero Inoxidable:

Limpie las superficies exteriores con un limpiador de acero inoxidable disponible comercialmente.

